



MOC Veranstaltungscenter München

DETAILS ON CONFERENCE ROOM K2

Spaces/rooms	Floor space in m ²	 Theater	 Classroom	 Banquet
K2A	74	54	28	24
K2B	79	54	28	28
K2 total*	153	144	74	52

*dividable room

The MOC Veranstaltungscenter München offers you six conference rooms ranging in size from 73 to 377 m² for 50 to 380 people. Our room offerings flexibly match your needs.

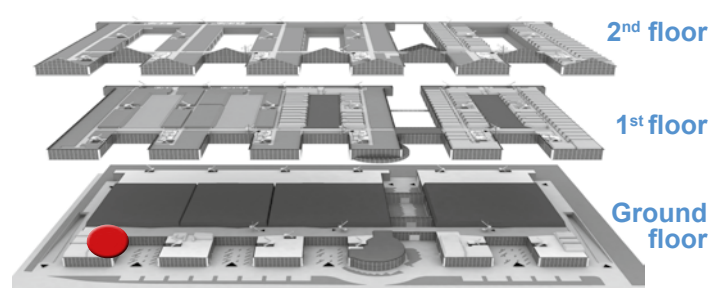

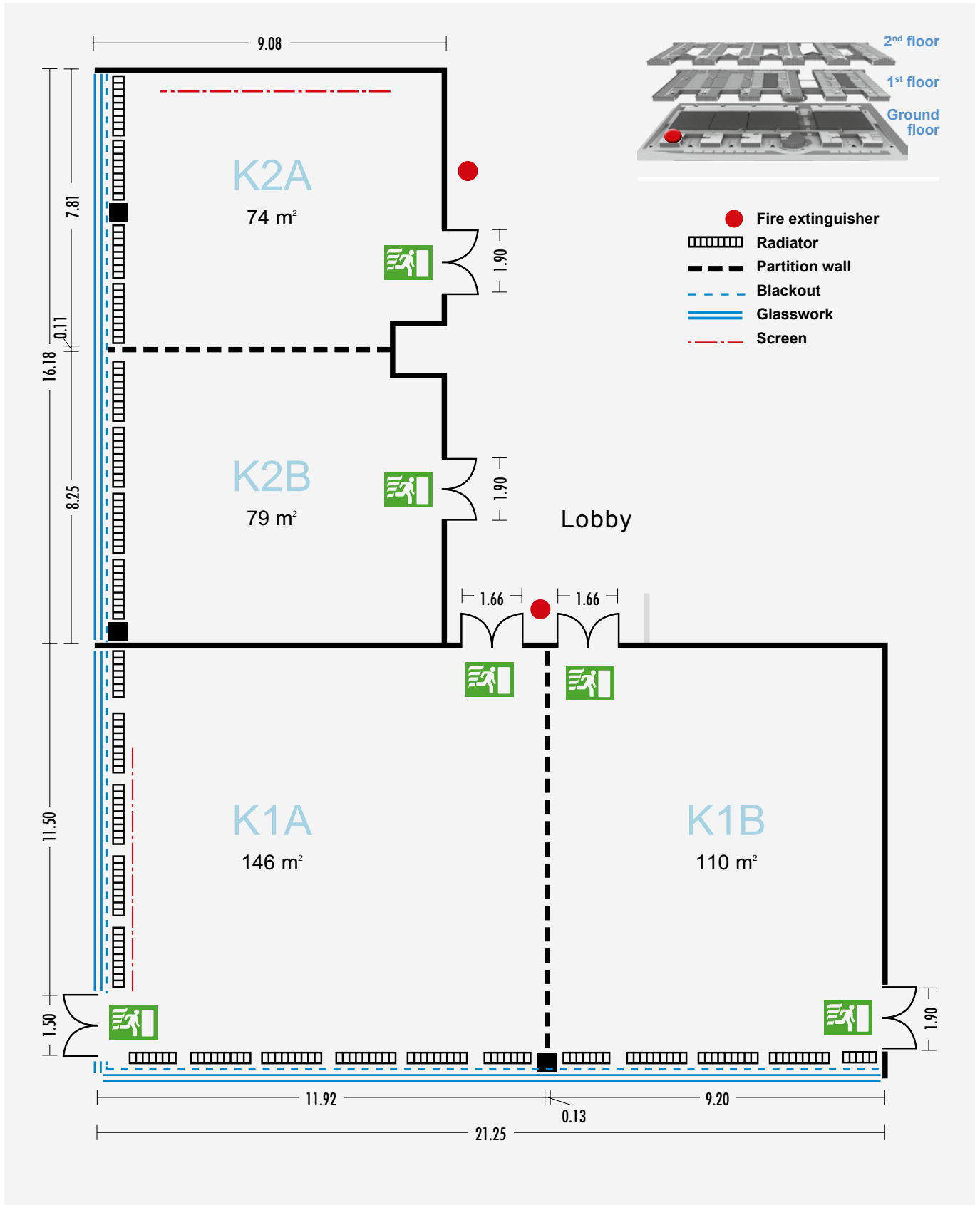

Technical data	
Size	<ul style="list-style-type: none"> Optional: K2A 74 m², K2B 79 m², K2 153 m²
Floors	<ul style="list-style-type: none"> Carpeting
Room height	<ul style="list-style-type: none"> 3,85 m
Communication	<ul style="list-style-type: none"> Connections for: <ul style="list-style-type: none"> Telephone Fax IP connections W-LAN for organizers
Conference equipment	<ul style="list-style-type: none"> high-quality speakers for good speech intelligibility provided as standard at each seat (does not include playback devices and microphones), use of projector ceiling-mount bracket and signal connection incl. electrical connection possible
Indoor climate	<ul style="list-style-type: none"> Ventilation system for heating and cooling
Lighting	<ul style="list-style-type: none"> dimnable lighting in the auditorium, lighting of stage area individually dimmable
Screen	<ul style="list-style-type: none"> Dimensions 3.0 m x 3.0 m
Blackout	<ul style="list-style-type: none"> Complete blackout possible Electronically controlled curtain
Sanitary Facilities	<ul style="list-style-type: none"> WC area in foyer, with separate facilities for handicapped

DETAILS ON CONFERENCE ROOMS K1 AND K2



MOC Veranstaltungszentrum München

CONFERENCE ROOM K2: THEATER SEATING

Spaces/rooms	Floor space in m ²	 Theater	 Classroom	 Banquet
K2*	153	144	74	52

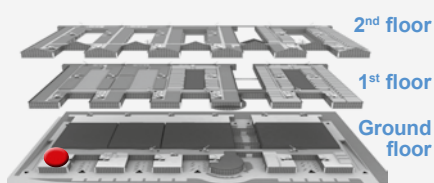
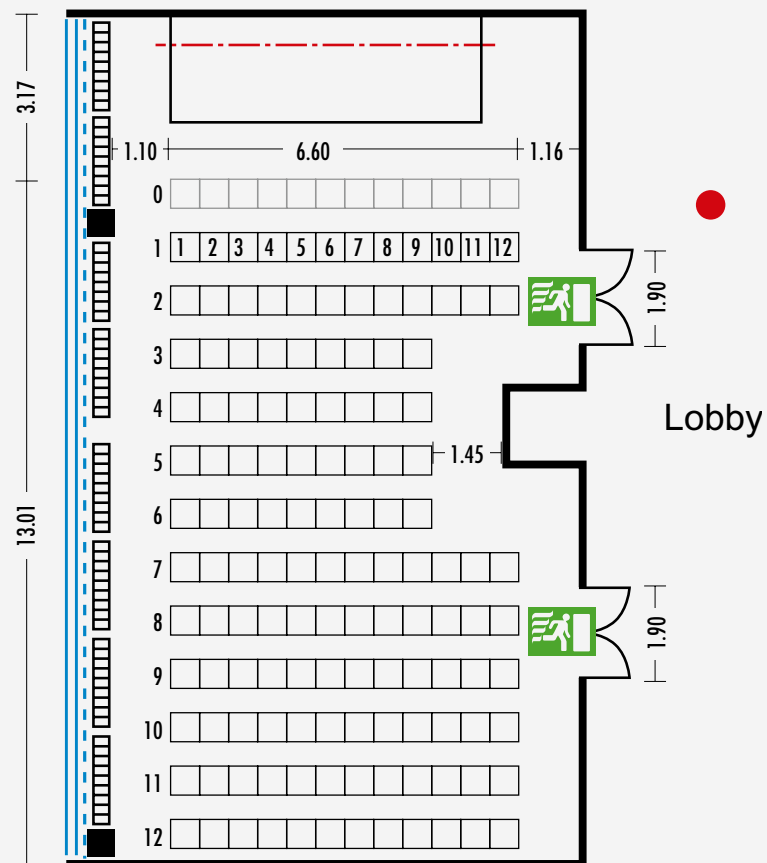

*dividable room



-  Fire extinguisher
-  Radiator
-  Partition wall
-  Blackout
-  Glasswork
-  Screen

MOC Veranstaltungszentrum München

CONFERENCE ROOM K2: CLASSROOM SEATING

Spaces/rooms	Floor space in m ²	 Theater	 Classroom	 Banquet
K2*	153	144	74	52

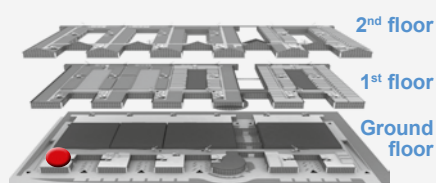
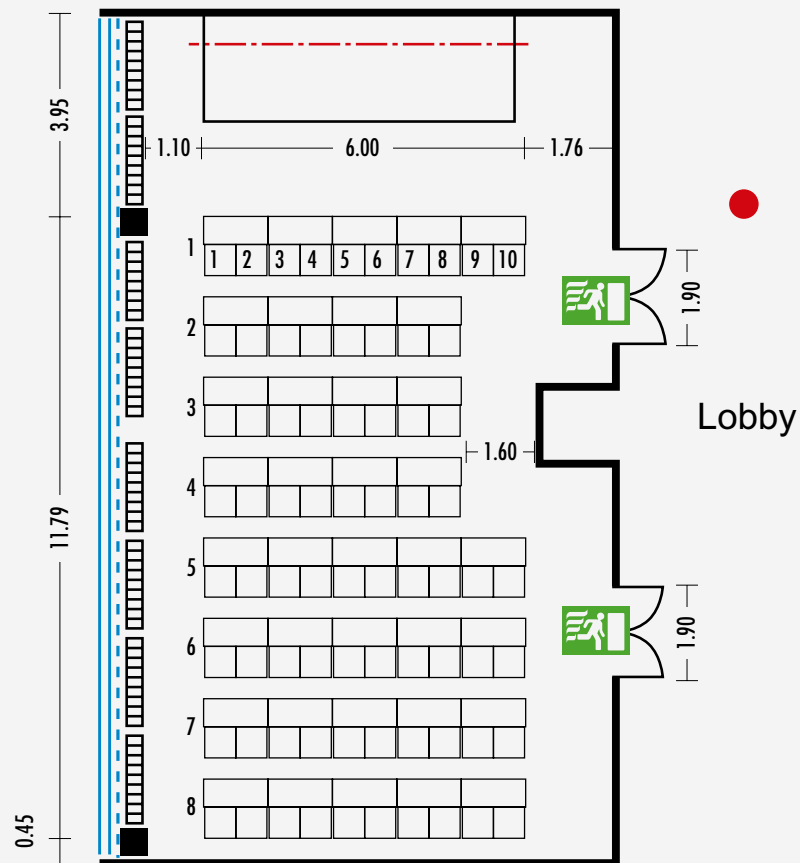

*dividable room



- Fire extinguisher
-  Radiator
-  Partition wall
-  Blackout
-  Glasswork
-  Screen

MOC Veranstaltungszentrum München

CONFERENCE ROOMS K2A AND K2B: THEATER SEATING

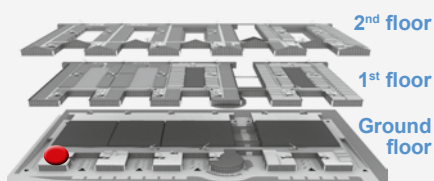
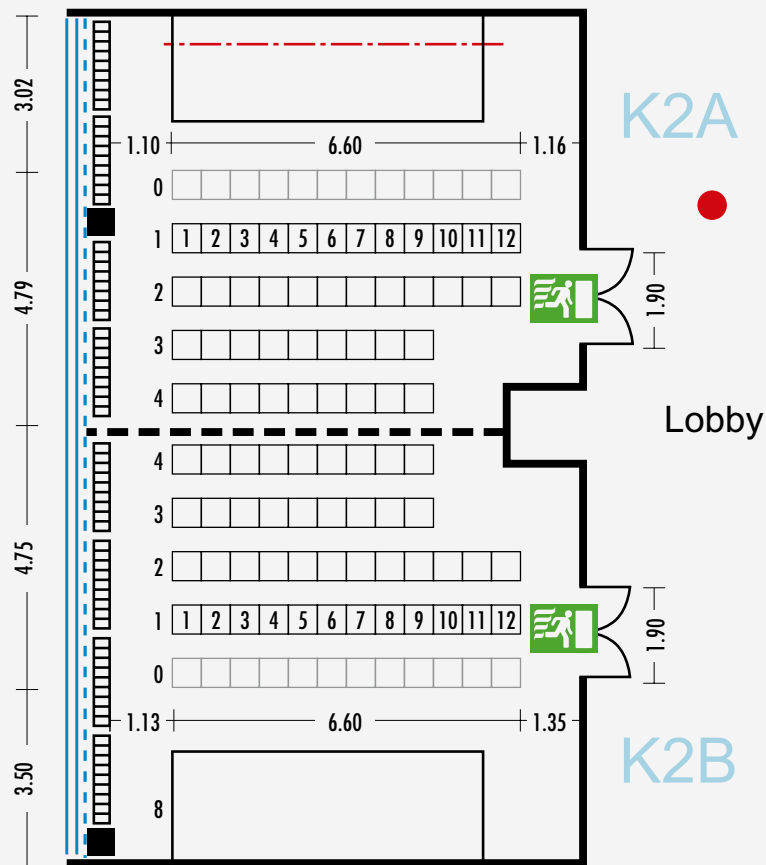

Spaces/rooms	Floor space in m ²	 Theater	 Classroom	 Banquet
K2A	74	54	28	24
K2B	79	54	28	28



-  Fire extinguisher
-  Radiator
-  Partition wall
-  Blackout
-  Glasswork
-  Screen

MOC Veranstaltungscenter München

CONFERENCE ROOMS K2A AND K2B: CLASSROOM SEATING

Spaces/rooms	Floor space in m ²	 Theater	 Classroom	 Banquet
K2A	74	54	28	24
K2B	79	54	28	28

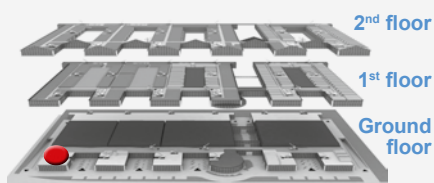
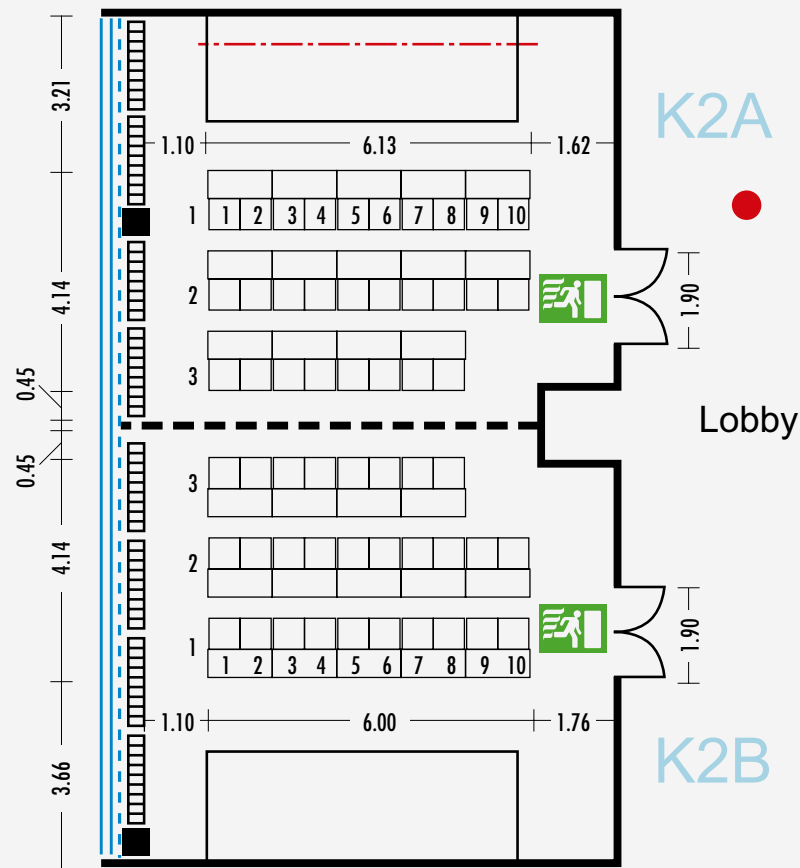

- Fire extinguisher
-  Radiator
-  Partition wall
-  Blackout
-  Glasswork
-  Screen